



**Cylindrical grinding - Cone grinding - Profile grinding -
Plunge grinding
on surface grinding machines!**



**RAPID 4.RS03.F
1069042A**

Application

1. Place the RAPID mini on the magnetic table of the surface grinding machine. Align the ground base plate at right angles to the magnetic stop bar and switch on the magnet..
2. Position the workpiece under the center of the grinding wheel.
3. Select the direction of rotation   at the control unit with or and thus switch on the spindle.
4. Allow the grinding wheel to lightly rub against the workpiece and determine the highest point on the workpiece by moving the machine table.
5. For cylindrical or taper grinding, the drive belt must be tensioned and the locking detent pin must be released. Switch on the motor and allow the workpiece to rotate.
6. When grinding surfaces or pitches:
Release the tension on the drive belt by loosening the tensioning screws of the motor holder on the top of the block and moving it in the slotted hole.
The motor must be at a standstill and the detent pin must be locked.

**Safety instructions
please note:**

- In the swiveled position, grind only against the gauge block support!
- Work only with belt guard!

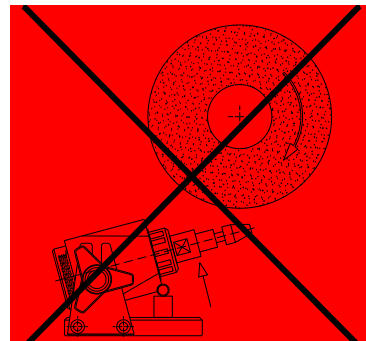
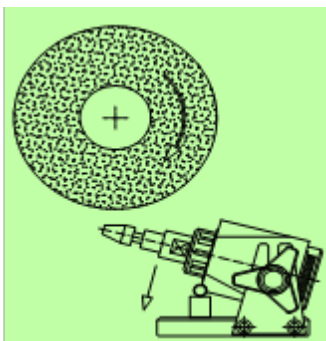

Service and maintenance:

- The RAPID mini grinding unit is equipped with sealing rings at the front and rear of the spindle as splash water protection. In case of heavy coolant use, an additional cover is recommended.
- **Cleanliness and careful treatment maintains your accuracy.**

Cone grinding:

- Can be tilted up to 45° (conditionally up to 90°). Insert gauge blocks according to attached sine table.
- For angular positions up to +45°, place gauge blocks under the front support axis.
- For angle settings up to -5°, place gauge blocks under the support axis according to the enclosed sine table.
- For angle +90°, align both support axes vertically. For additional support, a spacer bolt (included in the scope of delivery) can / should be screwed in through the belt guard.

Grinding with tailstock and rigid center punch:



- Pay attention to heat development, thin workpieces may bend.
- Heating of the drive motor up to approx. 60° is harmless.

Workpiece change:

- Lock the spindle with the locking pin. Loosen or tighten the workpiece clamping with the E32 wrench for collet nut.
- The spindle holder is prepared to accept E32 collets, Ø-range 2-20mm. Optional, collet reductions for ER11, for DECKEL S20x2, driving disc Ø80mm, three-jaw chuck Ø80mm, magnetic chuck Ø60mm, are available.

Check whether the voltage set on the fuse link matches your mains voltage!



1. Connect power cable and 5-pin connection cable.
2. The OFF key lights up.
3. For spindle rotation, select the desired direction of rotation to the right  or left .
4. The active key lights up.
5. Use the potentiometer to increase or reduce the speed.
6. Press OFF to stop the spindle rotation.

Technical data: RAPID 4.RS03.F (1069042A)

Support surface ca.	120x80mm	Weight ca.	9kg
Height (horizontal) ca.	110mm	Index-dividing head	15° (± 1min)
Height (vertical) ca.	175mm	Center height ca.	45mm
Tool holding fixture	E32 (für Spannzangen Ø 2-20mm)	Spindle runout	0,002mm
Drive	E-Motor, stepless adjustable, 0-300min ⁻¹ Right / left rotation switchable	Power connection	115-230V, 50-60Hz, 70W

© MPM, Technical changes reserved

Basic components

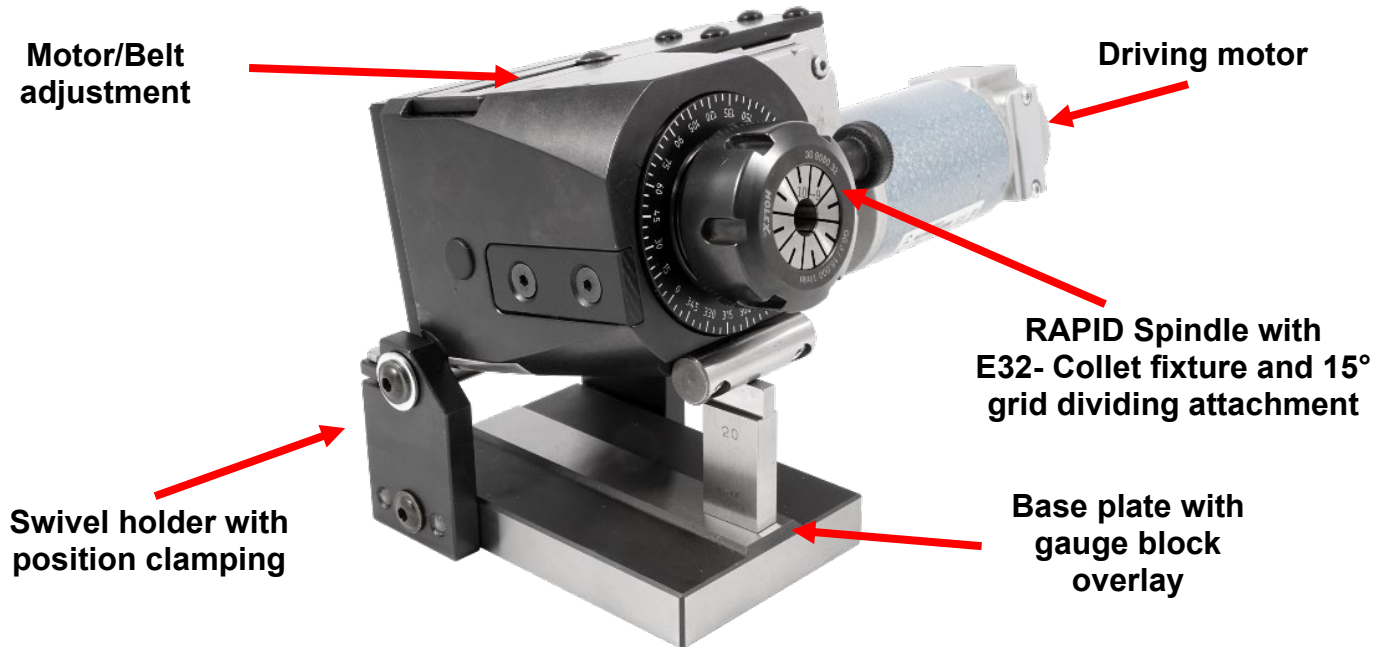

**RAPID the "Swiss knife"
 for your surface grinding machine!
 Many clamping options = rational help in prototyping!**

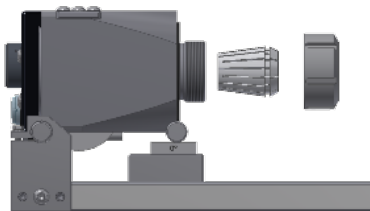

For E32 collets: 2-20mm (Standard)
 RAPID 4.RS03.F, 1069042A,
 For workpiece-Ø up to 80mm

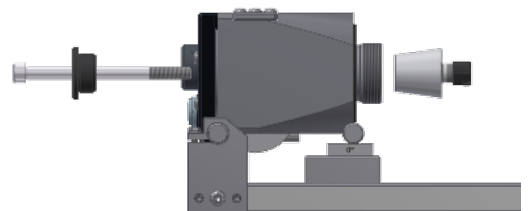

Adapter E32 for ER11 collets 1-7mm,
 1053704A
 Example: Grinding possible from Ø 0.3mm

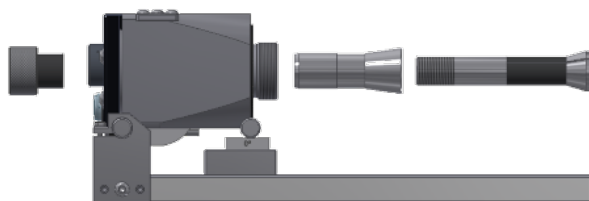

Adapter for DECKEL S20x2- collets 3-16mm,
 1047548A,
 Example: for existing DECKEL-collets

Simple clamping allows fast use

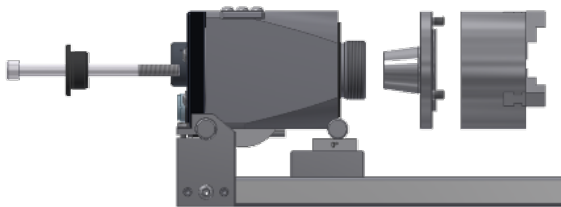

Adapter for 3-jaw chuck Ø 80mm,
 1007358A
 3-jaw chuck = 1011397A

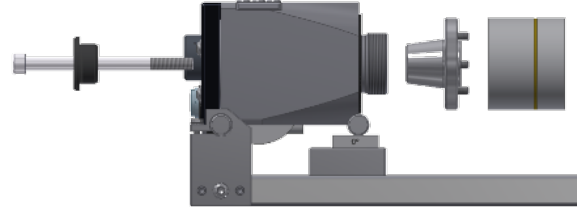

Adapter for magnet chuck Ø 80mm,
 1065448A
 Magnet chuck = 1047644A

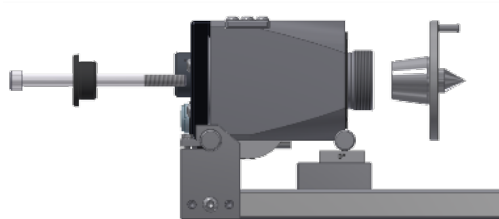

Driving disc Ø80mm, with E32
 1068675A

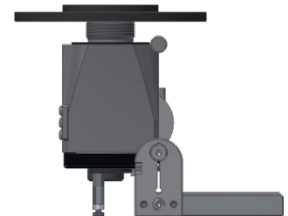

Swivel range from 0-90°



... and if you want to grind between tips, we recommend you to use:
RAPID 4.RS05.R, 1069556A
 (control unit and accessories are identical).

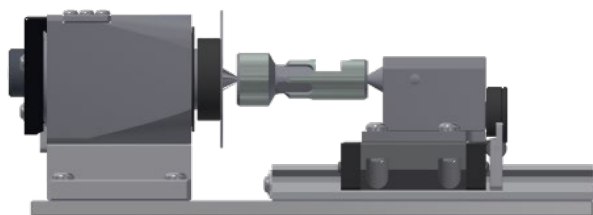

**MPM wishes you much success
 and pleasure with the grinding unit RAPID mini!**